

Climatix™ 600

HVAC&R controller

POL635.xx/xxx, POL636.xx/xxx, POL638.xx/xxx, POL638.70/xx



For controlling, switching and monitoring functions.

- Freely programmable Climatix POL63x controllers are designed for use in ventilation, air conditioning and refrigeration equipment.
- Create ventilation, air conditioning, and refrigeration applications using powerful engineering tools
- Easily commission plants with service tools

Application and features

Engineering	<ul style="list-style-type: none"> • Freely programmable • Graphical programming using Climatix SAPRO tool
Terminal	<ul style="list-style-type: none"> • Operating voltage AC 24 V or DC 24 V • 8 universal I/Os (configurable inputs / outputs, for analog or digital signals) • Power supply DC 24 V for active sensors • 5 digital inputs (potential-free contacts) • 2 analog outputs (DC 0...10 V) • 6 relay outputs (NO contacts)
Interfaces	<ul style="list-style-type: none"> • Local service connector for user interface (RJ45) and PC tools (USB) • Ethernet port for remote or local servicing using standard browsers (POL638.00 only) • Full modem RS-232 port for remote service • SD card interface for application and firmware upgrades
Operation	<ul style="list-style-type: none"> • Operating temperature without LCD -40...70 °C, with LCD -20...60 °C
Extensions	<ul style="list-style-type: none"> • I/O extension with extension modules (local/remote) • Third-party integration via integrated RS-485 supporting Modbus RTU • Networking over the process bus • Communication modules supporting Modbus, BACnet, LON and M-bus • LON field bus (POL636.00 only)

Topology

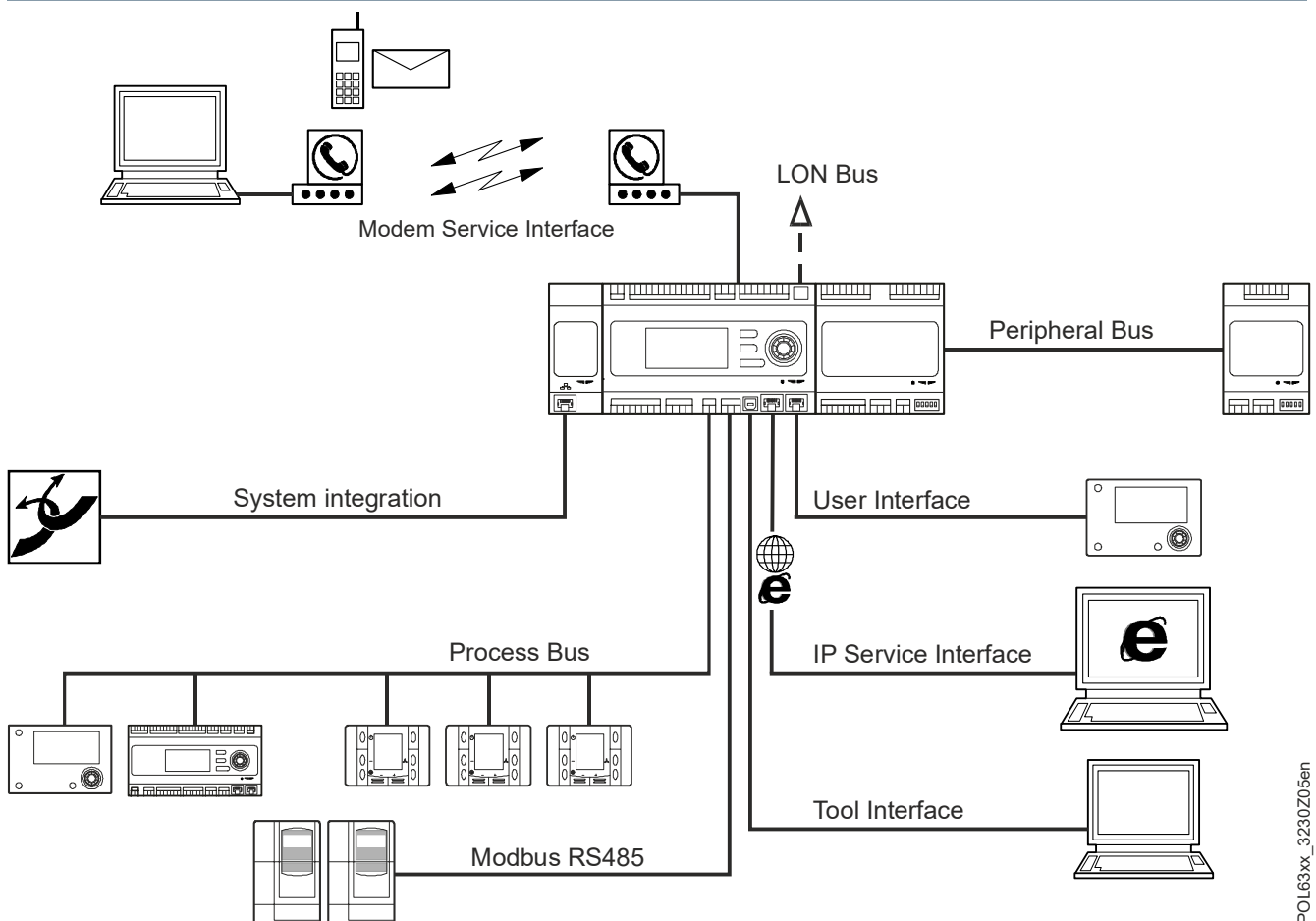

POL63xx_3230Z05en

POL635.xx/xxx, basic version SD card, modem, battery holder



POL636.xx/xxx, basic version with LON interface



POL638.70/xxx, basic version with HMI and TCP / IP interface



POL638.70/xxx, basic version with TCP / IP interface



General data

Weight (excl. packaging)	
Controller without HMI	422 g
Controller with HMI	487 g
Technical design	
Base	Plastic, pigeon-blue RAL 5014
Housing	Plastic, light-gray RAL 7035
Dimensions	
Dimensions of controller	180 x 110 x 75 mm

Overview

Power supply 8 universal Inputs / outputs 2 analog outputs 5 digital inputs LON interface (POL636.00 only)

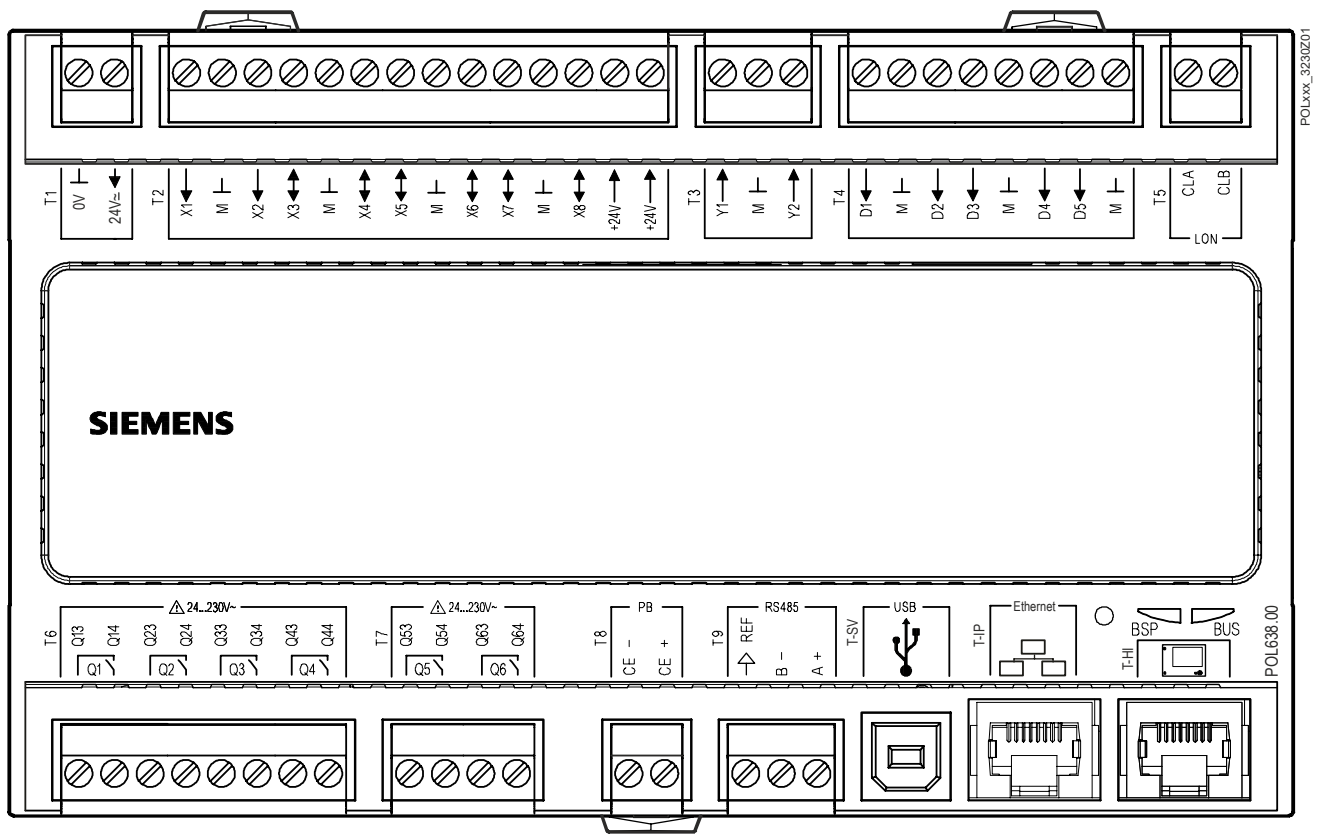

4 relay outputs 2 relay outputs Process bus (KNX) RS-485 (Modbus RTU) Tool (USB) Ethernet (POL638.00 only) HMI (RS-485)

i	NOTICE
	<ul style="list-style-type: none"> • Only POL636.xx/xxx has a LON interface • Only POL638.xx/xxx has an Ethernet interfac

Power supply

AC/DC 24 V (T1)	
Operating voltage	AC 24 V $\pm 20\%$; DC 24 V $\pm 10\%$
Frequency	45...65 Hz
Power consumption AC, without extension modules	Max. 1.8 A @ AC 24 V
Power consumption DC, without extension modules	Max. 1.0 A @ DC 24 V
Current consumption AC for extension modules *	Max. 2.2 A @ AC 24 V
Current consumption DC for extension modules *	Max. 3.0 A @ DC 24 V
External fuse in the supply line	Max. 6.3 A slow wire fuse or circuit breaker

* For calculation, see Q3900

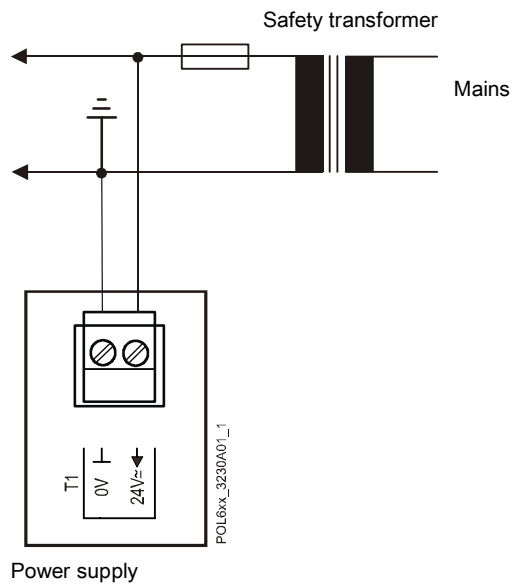

Inputs and outputs

Relay outputs Q1...Q6 (T6, T7)	
Relay: Type, contact	Monostable (NO contact)
Contact rating	
Switching voltage	AC 24...230 V (-20%, +10%)
Rated current (res. / ind.)	Max. AC 4 A / 3 A (cosφ 0.6)
Switching current at AC 19 V	Min. AC 30 mA
External fuse in the supply line	Max. 6.3 A slow wire fuse or circuit breaker

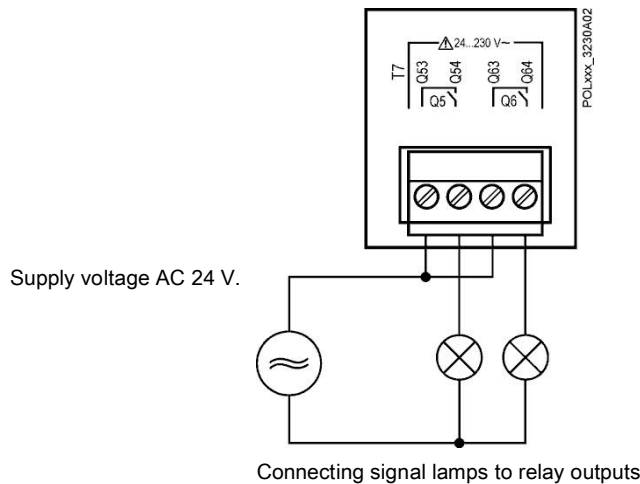

	<p>⚠ WARNING</p>
	<p>Note the following for installation:</p> <ul style="list-style-type: none"> • Do not mix SELV / PELV and mains power on the same terminal • Use external protection for inductive load

Universal I/Os X1, X2 only input, X3...X8 universal (T2)	
Configurable	Via software
Reference potential	Terminals ⊥
Contact voltage	Max. DC 24 V (SELV)
Overvoltage protection	Up to 40 V
Analog inputs (X1...X8)	
LG-Ni1000	
Sensor current	1.4 mA
Resolution	0.1 K
Accuracy within the range -50...150 °C	0.5 K
Pt1000	
Sensor current	1.8 mA
Resolution	0.1 K
Accuracy within the range -40...120 °C	0.5 K

Universal I/Os		
X1, X2 only input, X3...X8 universal (T2)		
NTC 10k		
Sensor current	140 μ A	
Temperature range	Accuracy	Resolution
-50...-26 °C	1 K	0.2 K
-25...74 °C	0.5 K	0.1 K
75...99 °C	1 K	0.3 K
100...124 °C	3 K	1.0 K
125...150 °C	6 K	2.5 K
NTC 100k		
Sensor current	140 μ A	
Temperature range	Accuracy	Resolution
-25...-11 °C	3 K	0.2 K
-10...9 °C	1 K	0.1 K
10...99 °C	0.5 K	0.1 K
100...150 °C	1 K	0.2 K
0...2,500 Ω		
Sensor current	1.8 mA	
Resolution	1 Ω	
Accuracy	4 Ω	

Ratiometric sensor

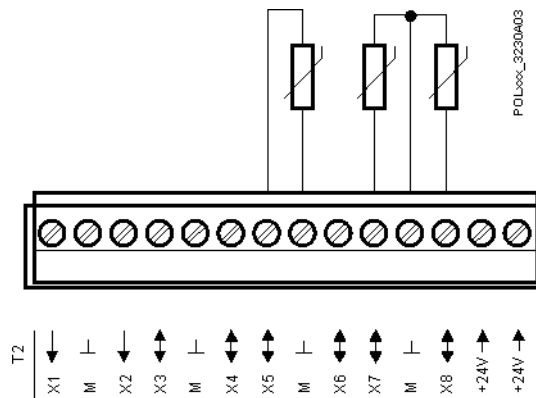

Connecting a NTC to universal I/O

DC 0...10 V input	
Resolution	1 mV
Accuracy at 0 V	10 mV
Accuracy at 5 V	25 mV
Accuracy at 10 V	50 mV
Input resistance	100 kΩ
DC 0/4...20 mA input	
Resolution	1 μA
Accuracy at 4 mA	40 μA
Accuracy at 12 mA	70 μA
Accuracy at 20 mA	120 μA
Input resistance	< 500 Ω

Voltage source
DC 0...10 V

Current transmitter
0...20mA

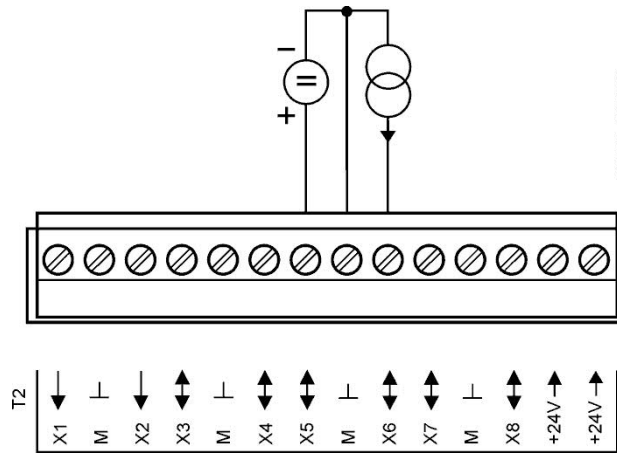

Voltage input DC 0...10 V and current input 0/4...20 mA

Digital inputs (X1...X8)	
0/1 digital signal (binary)	For potential-free contacts
Sensing voltage / current	DC 24 V / 8 mA
Contact resistance	Max. 200 Ω (closed) Min. 50 kΩ (open)

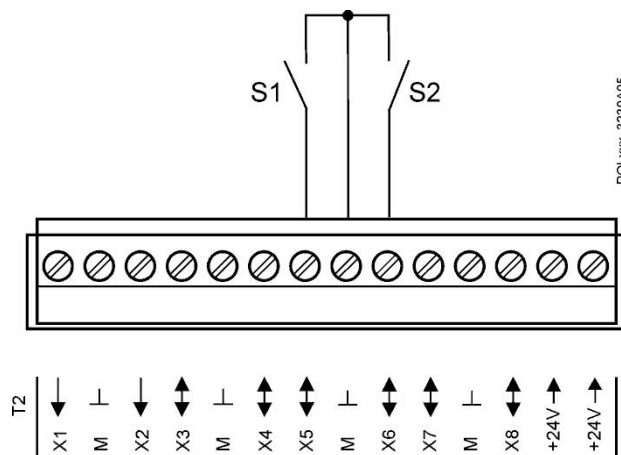

Connecting floating contacts to universal I/Os

Analog outputs (X3...X8)	
DC 0...10 V output	
Resolution	11 mV
Accuracy at 0 V	66 mV
Accuracy at 5 V	95 mV
Accuracy at 10 V	124 mV
Output current	1 mA (short-circuit-proof)

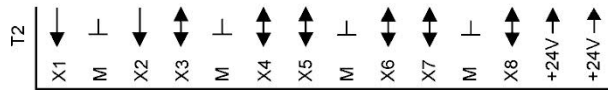
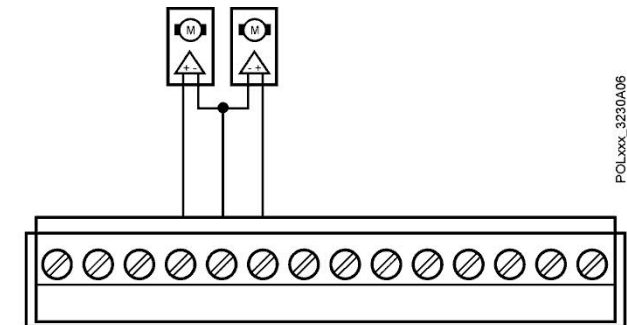

Control of actuators with 0...10V or 0...20mA analog signals

Digital outputs (X5...X8)	
DC output for off board loads	
Switching voltage	DC 24 V
Switching capacity	Max. 25 mA

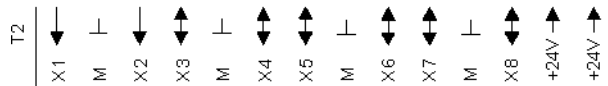
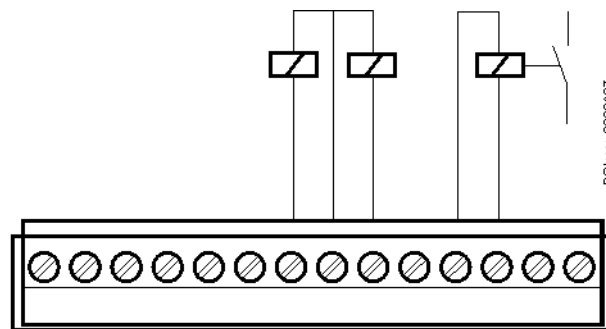

Connecting external relay to universal I/O

Power supply for active sensors, 2 outputs DC 24 V	
Voltage / current	DC 24 V +10 %, -25% / 2 x 40 mA
Reference potential	Terminals \perp
Connection	Short-circuit proof

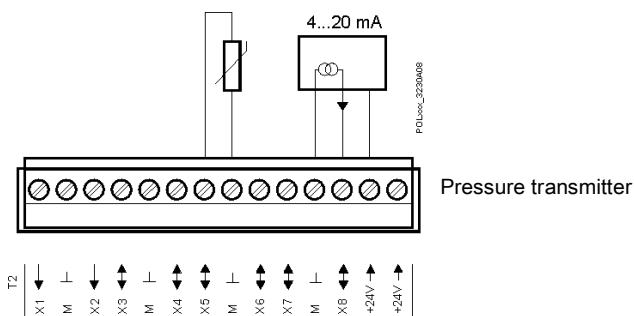

Connecting a sensor with AC 24 V supply voltage

Digital inputs, D1...D5 (T4)	
0/1 digital signal (binary)	For potential-free contacts
Sensing voltage / current	DC 24 V / 8 mA
Contact resistance	Max. 200 Ω (closed) Min. 50 k Ω (open)
Counter support: Pulse frequency	Max. 100 Hz

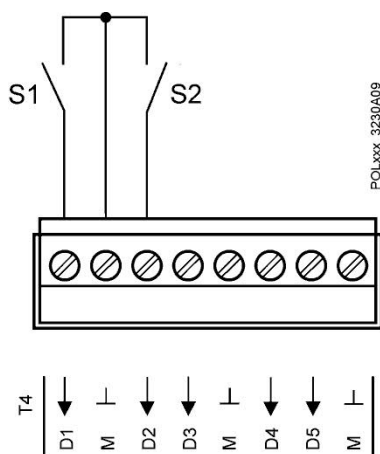

Connecting floating contacts to digital input

Analog outputs, Y1, Y2 (T3)	
DC 0...10 V output	
Resolution	11 mV
Accuracy at 0 V	66 mV
Accuracy at 5 V	95 mV
Accuracy at 10 V	124 mV
Output current	2 mA (short-circuit-proof)

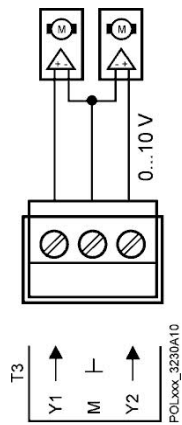

Control actuators with 0...10 V

Periphery bus	
<ul style="list-style-type: none"> • For connecting I/O Modules • Power supply: <ul style="list-style-type: none"> – via controller – separately AC/DC 24 V • Connection via plug at bottom right of the controller <ul style="list-style-type: none"> – local (board-to-board) – remote (board-to-wire) 	
Power supply via controller	See section "Power supply" of the controller
Separate power supply	96 VA limits also apply. Calculation per Q3900
Bus termination (fix)	680 Ω / 120 Ω +1 nF / 680 Ω
Board-to-board (not included)	ZEC 1.0/4-LPV-3.5 C1
Board-to-wire (not included)	ZEC 1.0/4-ST-3.5 C1R1
Solid wire	0.2...1.0 mm ²
Stranded wire (twisted and with ferrule)	0.2...1.0 mm ²
Cable lengths	Max. 30 m



Process bus CE+, CE- (T8)	
Process bus	Based on KNX TP1 (refer to KNX Manual)
Bus connection 2-wire (twisted pair)	CE+, CE- (not interchangeable)
Bus connection / electronics	Galvanically separated
Bus load	Max. 5 mA
Bus cable	Must be shielded (see KNX Manual "System Specifications")
Bus cable length between 2 KNX nodes	Max. 700 m
Total length of KNX bus cable	Max. 1,000 m
Bus power supply via	Internal DPSU with 50 mA rated current External standard KNX power pack

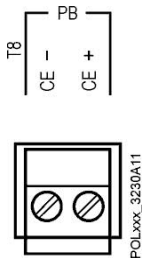

Connecting the process bus

Modbus (RS-485, RTU) A+, B-, REF	
RS-485 (EIA 485)	Modbus RTU mode 2-wire twisted pair (shielded)
Bus connection	A+, B-, REF
Bus electronics	Not galvanically separated
Bus cable	Shielded if length > 3m , twisted pair
Bus termination (switched via software)	680 Ω / 120 Ω +1 nF / 680 Ω

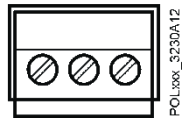
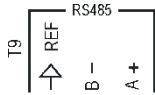

Modbus connection

Communication module interface	
<ul style="list-style-type: none"> • Connection via plug at bottom left of the controller. • Based on SPI interface for the communication module connection. 	
Number of COM modules	Max. 3 (self-acting module detection)
Power supply	DC 5 V ±10% / max. 1A (short-circuit-proof)
Board-to-board (not included)	ZEC1.0/10-LPV-3.5 GY35AUC2C11



Local HMI interface (T-HI)	
Connection	RJ45 jack (8 pins)
Cable (< 3 m)	<ul style="list-style-type: none"> • Use USB cable POL0C2 for tools • HMI cable included in POL895.51
HMI communication	RS-485
HMI power supply	24 V max. 100 mA
Bus termination (fix)	680 Ω / 120 Ω +1 nF / 680 Ω

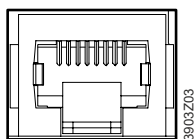
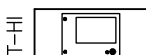

Service tool interface (T-SV)	
Connection	USB type B
Standard cable	Length of cable <3 m

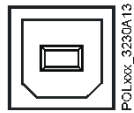
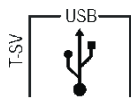

USB interface

Ethernet service interface TCP/IP, (T-IP)	
Communication	10/100 Mbit (IEEE 802.3U)
Cable connection	RJ45 jack (8 pins)

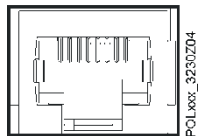
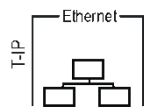

Connection TCP/IP

Ethernet TCP/IP example:

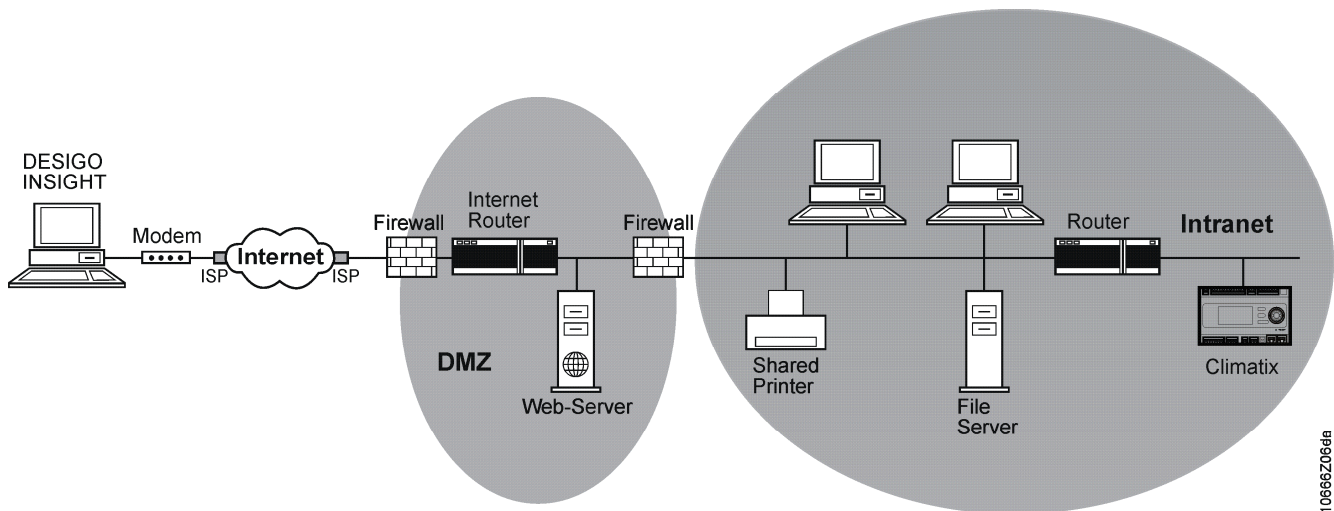

10666206de



Only POL638.00/xxx has an Ethernet interface.

Modem service interface	
Connection via plug at top of the controller	
Cable connection	RJ45 jack (8 pins) Cable length <3 m
Supported modem types	Siemens TC65 GSM modem terminal Devolo Microlink 56k I

SD card	
Connection via plug at top of the controller	
Card types	SD, SDHC
Card size	128 MB...32 GB
File system	FAT16, FAT32

!	NOTICE
	Loss of data Switching on/off during the read-and-write access can lead to loss of data.

LON interface CLA, CLB-	
Plug-in terminals	2-wire (interchangeable) 2-wire, twisted pair, shielded
Galvanically separated	



Only POL636.00/xxx has a LON interface.

Cable types

Connection terminals	
Solid wire	0.5...2.5 mm ²
Stranded wire (twisted and with ferrule)	0.5...1.5 mm ²
Cable lengths	In compliance with the load, local regulations and installation documents

Cable types	
Process bus	Twisted pair; 0.5...1.5 mm ² (per KNX specification)
RS-485 interface	2-wire, twisted pair, shielded
Periphery bus	4-wire (2 wires as twisted pair), shielded

Environmental conditions	
Operation	IEC 60721-3-3 class 3K5
Temperature	-40...70 °C
Restriction LCD	-20...60 °C
Restriction process bus	-25...70 °C
Restriction with 1 COM module	-40...65 °C
Restriction with 2 COM modules	-40...60 °C
Humidity	<90% r.h. (non-condensing)
Air pressure	Min. 700 hPa (corresponding to max. 3,000 m above sea level)
Mechanical conditions	IEC 60721-3-3 class 3M2
Transportation	IEC 60721-3-2 class 2K3/2K4
Temperature	-40...70 °C
Humidity	<95% r.h. (non-condensing)
Air pressure	Min. 260 hPa (corresponding to max. 10,000 m above sea level)
Mechanical conditions	IEC 60721-3-2 class 2M2

Reliability	
MTBF	24 years

Protection	
Housing type	IP20 (EN 60529)
Protection class	II

Standards, guidelines	
Product standard	EN60730-x
Electromagnetic compatibility (application range)	For residential, commercial and industrial environment
EU conformity (CE)	CB1T3231xx
RCM conformity	CB1T3909en_C1
UL approvals	UL916, UL873 http://database.ul.com/
Signal equipment certified for Canada	CSA Class 4812 http://www.csagroup.org

Environmental compatibility
Product environmental declaration CB1E3230_01 contains data on environmentally compatible product design and assessments (RoHS compliance, materials composition, packaging, environmental benefit, disposal).

LEDs for diagnostics

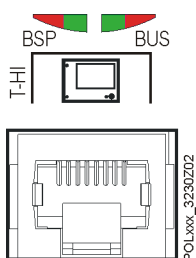

LED BSP "Run / Stop": 3 colors (green, red, and orange)

Mode	LED
SW update mode (download application or firmware)	Every second alternating between red and green
Application running	Green on
Application loaded, but not running	Orange on
Application not loaded	Orange flashes: 50 ms on, 1000 ms off
Firmware error	Red blinking at 2 Hz
Hardware fault	Red on

LED BUS: 3 colors (green, red and orange)

- This LED only indicates the status of modem communication.

Mode	LED
No modem connected, or LED disabled	Off
Modem connected and initialized no communication active	Orange on
Modem connected and communication active	Green on
Modem connected but errors active (like provider missing, no initialization possible)	Red on

Real-time clock	
Buffering with internal gold cap	Min. 3 days
Buffering with accessory battery	Min. 200 days

Built-in HMI	
LCD resolution	144 x 64 pixels
Backlit display	White
Navigation pane	Roll-and-push knob 3 function buttons

Order data

Basis controller	POL635.00/xxx
Basic controller with LON interface	POL636.00/xxx
Basic controller with TCP/IP interface	POL638.00/xxx
Basic controller with TCP/IP interface and HMI	POL638.70/xxx

Accessories

Type	Description
POL063.85/STD	Plug set, screw type, side entry MVSTBW (not included)
POL063.86/STD	Plug set, spring cage type, top entry FKCT (not included)

Suitable plug Phoenix types for the controller:	
1 x 2 position - MVSTBW, FKCCW or FKCT 2.5/2-ST	Orange
3 x 2 position - MVSTBW, FKCCW or FKCT 2.5/2-ST	Gray
3 x 3 position - MVSTBW, FKCCW or FKCT 2.5/3-ST	Gray
1 x 4 position - MVSTBW, FKCCW or FKCT 2.5/4-ST	Gray
2 x 6 position - MVSTBW, FKCCW or FKCT 2.5/6-ST	Gray
2 x 8 position - MVSTBW, FKCCW or FKCT 2.5/8-ST	Gray

Product documentation

Document ID	Title	Description
M3910	Climatic mounting instructions	Connecting extension modules. Power variants.
Q3993en	EMC design guidelines	Notes on EMC, especially for panel design
A6V101099058_en	Climatix: Technical Limits	Technical limits of the controller and possible integration

Notes

Engineering: Panel

	<p>⚠ WARNING</p> <p>Risk of electric shock by unintentional contact with electrical connections Touching powered connections (over 42 Volt) can result in serious injury.</p> <ul style="list-style-type: none"> • Install the device in a protective housing (preferably a panel). • A key or tool is required to open the protective housing. • AC 230 V cable must be double insulated versus safety extra-low voltage (SELV) cables.
---	---

Disposal

	<p>The device is considered an electronic device for disposal in accordance with the European Guidelines and may not be disposed of as domestic garbage.</p> <ul style="list-style-type: none"> • Dispose of the device through channels provided for this purpose. • Comply with all local and currently applicable laws and regulations.
---	--

Overview of software licenses

These devices use Open-Source-Software (OSS), please consult the OSS document for the applicable controller type and valid version set (VVS).

Title: License Summary Climatix 600 Controller – VVS10

Title: License Summary Climatix 600 Controller – VVS11

POL63X.00/XXX

