



CLIMATIX™

## Room units with 2-wire interface

**POL822.60/XXX**  
**POL822.70/STD**

For Climatix controller range POL6XX or POL4XX

- Measurement of the room temperature
- Keys for adjustment of the room temperature set point, the energy mode, fan control, time settings and etc.
- LCD display of room temperature, operating modes, energy modes, time, fan steps and weekday
- 2-wire interface to the controller by using Climatix process bus (KNX)
- Adjustable commissioning and control parameters
- Semi-flush mounted on all European recessed installation boxes
- Programmable time scheduler function
- Display, Icons and functions are highly flexible and programmable by Climatix controller according application field
- 2 types are available:
  - POL822.60/XXX: 6 key with time scheduler function
  - POL822.70/STD: 6 key with time scheduler function for heating application

## Topology of POL6XX

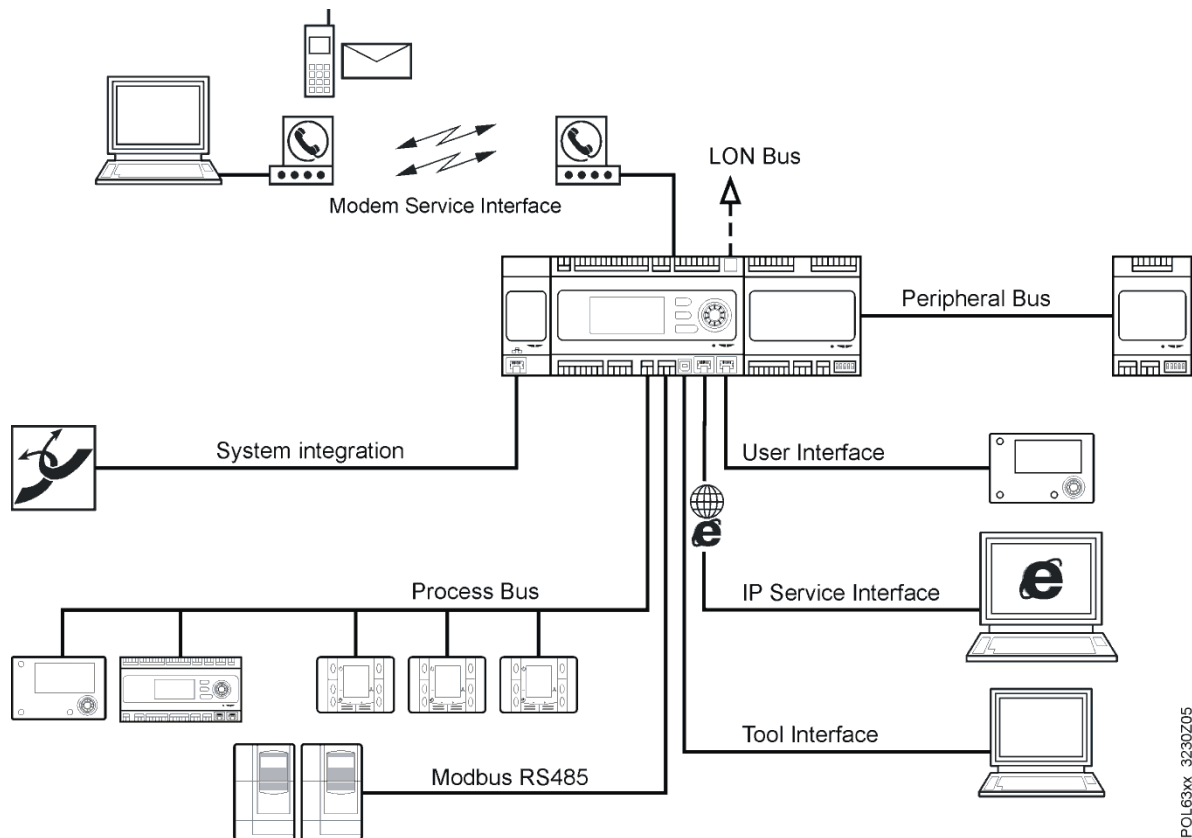

POL63xx\_3230Z05

## Use

The room unit is used in rooms controlled by an individual room control system, to measure the room temperature and operate a room controller.

## Ordering

<i>Product number</i>	<i>Stock number</i>	<i>Designation</i>
POL822.60/XXX	S55626-H226-Axxx	Climatix HMI-SG for ventilation application
POL822.70/STD	S55626-H227-A100	Climatix HMI-SG for heating application

When ordering, please specify the quantity, product name and the type code and consider the minimum order quantity.

Example                      24     Room units     POL822.60/XXX

## Mechanical design

The room unit is designed for semi-flush surface mounting with a recessed conduit box. The cable entry is through the rear of the unit.

The unit comprises front housing and rear housing, that can be locked together and released by a snap-mechanism. Both the housings are plastic.

The housing accommodates:

- Printed circuit board
- Room temperature sensor element
- Key buttons for
  - mode selection
  - set-point adjustment
  - timer setting
  - fan speed selection
- LCD panel

The mounting plate accommodates the screw terminals for local bus connection.

Opening/closing the housing

Please refer to Mounting Instruction CB2M3261.

## Operator controls



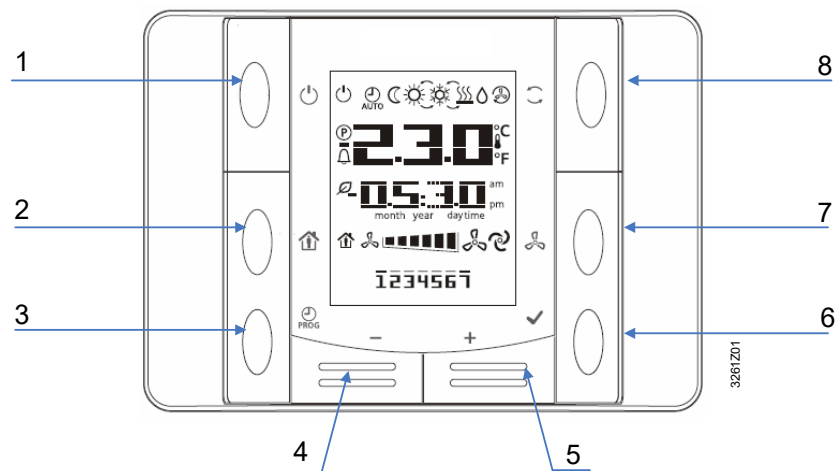

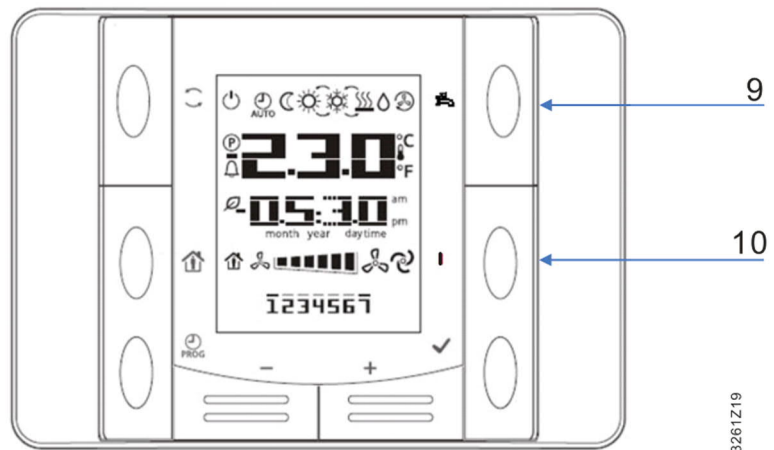

POL822.60/XXX



POL822.70/STD



## Legend

No.	Icon	Name	Functions
1		<b>ON/OFF</b>	Button for power on or power off
2		<b>Presence</b>	Button for entering or exiting a present mode which is programmed.
3		<b>Program</b>	Button for Time Scheduler, pressing this button allows date/time setting, while holding it allows schedule programming
4	-	<b>Minus</b>	Button for set-point adjustment, each operation of the <b>Minus (-)</b> button reduces the set point by 0.1 °C/0.5 °F or 0.5 °C/1.0 °F which is defined in controller's setting.
5	+	<b>Plus</b>	Button for set-point adjustment, each operation of the <b>Plus (+)</b> button increases the set point by 0.1 °C/0.5 °F or 0.5 °C/1.0 °F which is defined in controller's setting.
6		<b>OK</b>	Button for confirmation of date/time and scheduler settings
7		<b>Fan</b>	Button for fan speed, the fan speed is set up in grades by controller. By pressing <b>Fan</b> button, the grades can be selected clockwise in a cyclic way. The current grade selected manually is indicated by the lit bar on the screen.
8		<b>Mode</b>	Button for 3 energy modes: Auto, Comfort and Economy. By pressing <b>Mode</b> button, the user can switch HMI-SG between the 3 modes in a cyclic way. The current mode manually selected is indicated by relevant symbol on the screen.
9		<b>Domestic hot water</b>	Adjustment for domestic hot water ( <i>only for POL822.70/STD</i> ).
10	<b>i</b>	<b>Information</b>	Information ( <i>only for POL822.70/STD</i> ).

## Display Panel

The display panel shows actual room temperature, set point, energy mode, fan speed, time, weekday and etc. The graph below is an overview of contents that may show on the display panel.



The following table lists the meanings each icon on the display panel represents:

No.	Contents	Meanings
1		Temperature area, it shows room temperature and set point in °C and °F, The temperature unit can be selected in service mode of room unit if relevant option was created by the controller. Please see examples as follows.
		Room temperature in °C (resolution 0.1 °C)
		Room temperature in °F (resolution 0.5 °F)
		Set point, it can be adjusted and displayed in Centigrade or Fahrenheit; resolution is 0.1°C/0.5°F or 0.5°C/1.0 °F.
2		Time
3		Fan speed
4		Weekday indicator
5		ON/OFF
6		Auto mode active
7		Economy mode active
8		Comfort mode active
9		Cooling
10		Heating
11		Dry (free cool) sequence is active
12		Recirculation (fan only) sequence
13		Automatic fan control
14		Present mode
15		Energy recovery
16		Alarm indicator
17		Service mode

For example, the following contents will be displayed on LCD:

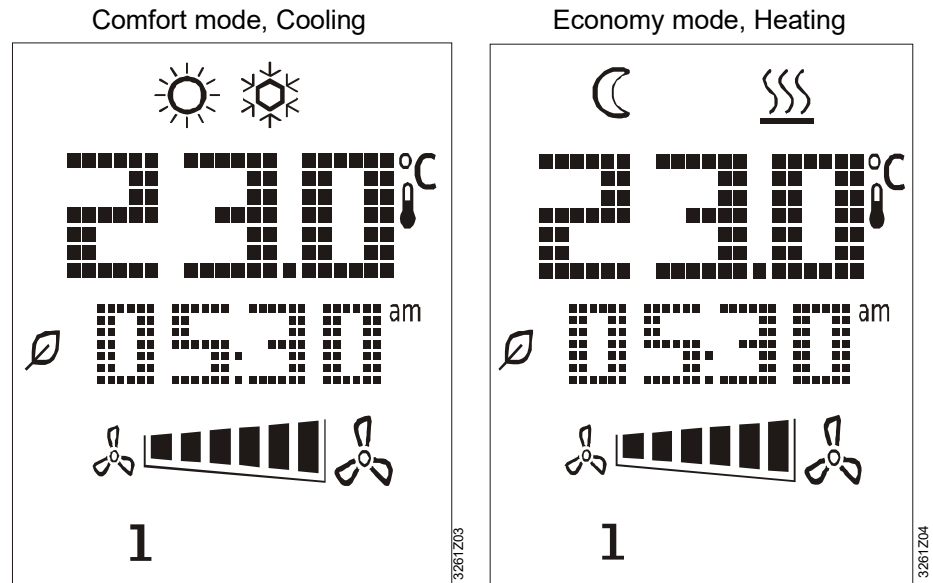

**Setting date and time**

- By pressing **PROG** button, user will enter time and date setting.
- Pressing button **Plus** or **Minus** can change the variables those are blinking on the screen.
- Pressing **OK** button will confirm the changes and the cursor will move to the next variable automatically.

**Workflow**

1. The first view is time setting, user can change 3 items: hour, minute and time format. The view is showed as follows:

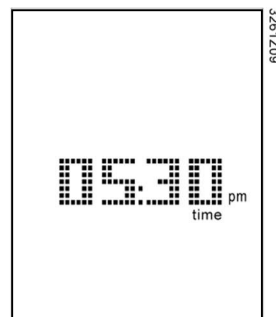

2. Firstly the hour area will be blinking; pressing button **Plus** or **Minus** can change the number of hour, pressing **OK** will confirm the changes and the cursor will move to the minute area automatically.

3. After the number of minute is confirmed, the whole time area will blink. Pressing button **Plus** or **Minus** will switch time format between 12-hour with AM/PM and 24-hour. The view is showed as follows in 24-hour time format:

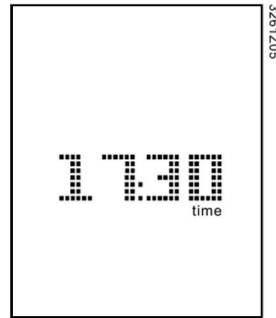

4. After the time format is confirmed, HMI-SG will jump to the view of year. The view is showed as follows:

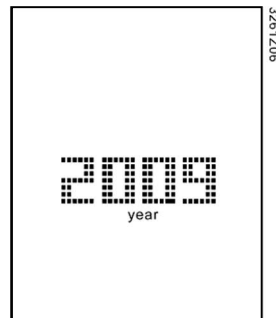

5. After the year is confirmed, it will jump to the view of month and day. The view is showed as follows:



6. After the month and day is confirmed, HMI-SG will return to the view of time. Press button **PROG** or there is no any operation for 1 minute, it will exit the setting.

#### Note

There is no real clock in HMI-SG. Controller sends the exact time periodically to HMI-SG for synchronization.

## Setting time scheduler

- HMI-SG is integrated with time scheduler function.
- The scheduler is working with 7 weekdays and 6 switches can be set up for each day.
- By setting up the switch, the user can set a time point and select one operation in **Auto** mode.
- The contents of operation are defined in controllers, and maximum 10 operations can be defined.
- After setting up the switch, the selected operation will be performed automatically at the time point.

## Workflow

1. Hold **PROG** button.  
In time scheduler, **PROG** button is used to cancel while **OK** to confirm.

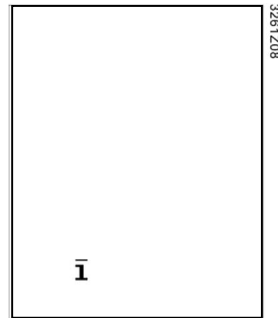

2. Pressing button **Plus** or **Minus**, the number of corresponding weekday will blink on screen. Holding button **Plus** or **Minus**, cursor will keep on moving on the weekdays in a cyclic way.
3. When cursor moves onto one weekday, pressing **OK** button will select this number or deselect it. When one weekday is selected, the day will be displayed on screen constantly. More than one weekday can be selected.

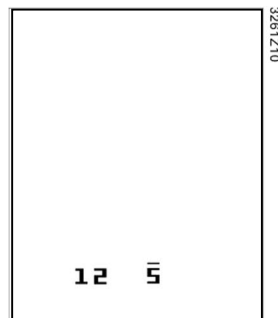

4. When cursor reaches the end of the week (i.e. 7) by pressing button **Plus** or the beginning of the week (i.e. 1) by pressing button **Minus**, all the selected weekdays will be displayed on screen with their indicators blinking. Pressing **OK** once will confirm them all.

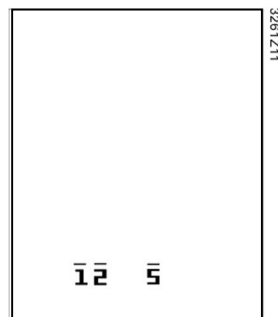



5. After the confirmation of weekdays, pressing **Plus** or **Minus** again will jump to the following view.  
The first line is number of operation; the second line is time setting, the invalid time "--:--" is used to add a switch.

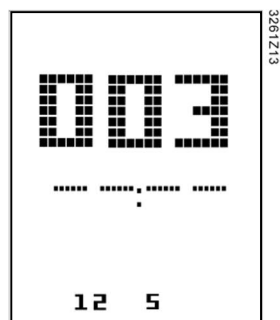

6. Press button **Plus** and **Minus** to set up time point and select an operation, and press **OK** to confirm the input. In any parts of time area, press **OK** when the cursor is located on "--" without a number is selected, the switch will be deleted, and HMI-SG will go back to viewing switch.

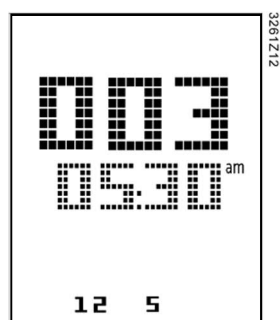

7. In scheduler setting, pressing **PROG** button will go back to the previous page. User can press this button to exit the setting step by step. HMI-SG will also exit time scheduler setting automatically if no operation was performed for 1 minute, and all changes made after pressing **OK** button will not be saved.

- Parameter initialization** After the HMI-SG is connected to the controller and the communication is set up, it will start parameter initialization. Parameter indicator (**P--**) will be displayed on screen for a while. After parameter initialization is completed, it will be in normal view. The parameter can be edited in service mode.
- Access level** In service mode, there are 3 access level of parameter identified from C1 to C3:
- C1 Service engineers
  - C2 OEM
  - C3 Reserve
- Note For each access level, a password can be assigned. The password consists of 4 digits and each with the range of 0 to 9.
- Parameter privilege** There are 2 parameter privilege settings:
- Read Only (RO) -- The parameter can be read but user cannot change the value.
  - Read/Write (RW) -- The parameter is readable and changeable.
- Group and plain list** Parameters are represented either in groups or as plain list.
- The format of grouped parameter is: "Xnn". "X" is a letter as the leading group name and "nn" is the sequence number within the group. There are totally 10 groups in HMI-SG. For each group there are max 100 parameters.
- The format of plain list is: "nnn". The "nnn" represents the sequence of parameters. In total, 1000 parameters (000~999) can be represented.
- Service mode** By holding **Plus**, **Minus** and **Mode** button at the same time, HMI-SG will enter service mode. The functions of keys in service mode are:
- Button **ON/OFF**: Cancel or go to previous page.
  - Button **Mode**: confirm.
  - The combinations of buttons described here are valid for all POL822.X0/XXX devices, independent of specific naming.
  - No operation for 1 minute will exit service mode.
- Edit parameter
1. Hold **Plus**, **Minus** and **Mode** button at the same time. HMI-SG enters service mode, and the page of inputting password will be displayed.

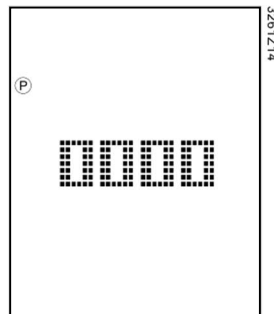

2. Press **Plus** or **Minus** to input password, press **Mode** to confirm it. If the password is correct, HMI-SG will show a new view for user to select group name.

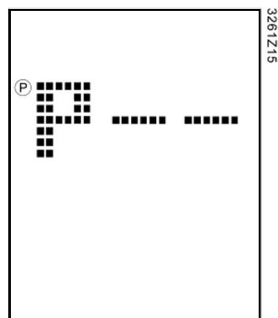

**Note**

If no group exists for some reason or the password is wrong, "----" will be displayed again.

3. Press **Plus** or **Minus** to select a group name, press **Mode** to confirm it, and then the following view will be shown. The numbers of the first line represent parameter ID, and the number of the second line represent its value.

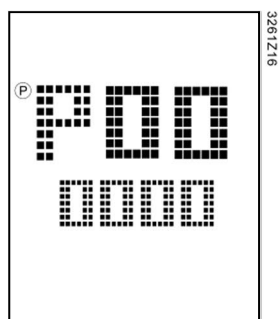

4. Press **Plus** or **Minus** to choose parameter ID, and press **Mode** to edit its value.
5. If the current access level have privilege RW, the value of parameter will blink and the user can edit it; otherwise the parameter ID will keep blinking.
6. Press **Plus** or **Minus** to change the value. After confirming the value with **Mode** button, it will go back to viewing parameter ID.

**Diagnostic mode**

By holding button **ON/OFF**, **Mode**, **Plus** and **Minus**, the HMI-SG will enter into diagnostic mode. The functions of keys in diagnostic mode are:

- Button **ON/OFF**: Cancel or go to previous page.
- Button **Mode**: confirm.
- The combinations of buttons described here are valid for all POL822.X0/XXX devices, independent of specific naming.
- No operation for 1 minute will exit service mode.

This mode is used to view and edit local parameters.

Edit local parameter

HMI-SG software version and build number will be shown when coming to diagnostic mode. The software version includes 3 digits and the build number 4 digits.

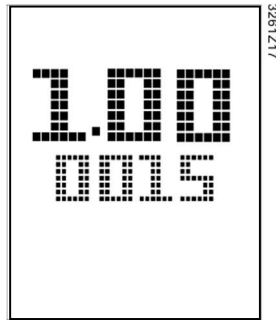

In diagnostic mode, pressing **Mode** button can view the following 9 local parameters. Some local parameters are read-only (RO), and others are read-writable (RW), the local parameter view will show as follows:

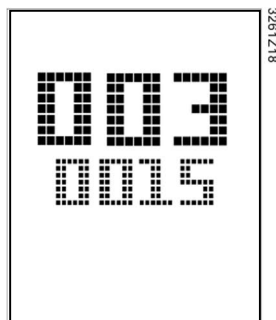

Note

- The individual address of different HMI-SG on one network should not be identical. The viewing and editing process of parameter is the same as "**edit parameter**" in service mode.

No.	Local Parameters and Descriptions
001	<b>KNX connectivity (RO)</b> In KNX connectivity page, if there is any KNX frames received in the last 70 seconds, "OK" will be shown to indicate KNX bus is activated, otherwise, "NG" will be shown.
002	<b>KNX individual address – line address (RW) - (X.1.1)</b> The range of the address value is 0 to 15.
003	<b>KNX individual address – area address (RW) - (1.X.1)</b> The range of the address value is 0 to 15.
004	<b>KNX individual address – device address (RW) - (1.1.X)</b> The range of the address value is 1 to 252.
005	<b>KNX geographic address apartment (RW) (X.1.1)</b> The range of apartment number is from 1 to 126.
006	<b>KNX geographic address Room (RW)(1.X.1)</b> The range of room number is from 1 to 14.
007	<b>KNX geographic address Sub-zone (RW)(1.1.X)</b> The range of subzone number is from 1 to 15.
008	<b>Network failure detection Enable (RW)</b> This parameter enables or disables the function of network failure detection. If it is enabled and there is no any KNX frames received for 70 seconds, "NET" will display and blink on screen. Note: The net failure detect timeout is 30 seconds during parameter initialization.
009	<b>Auto individual address assigned enable (RW)</b> If the parameter is 0, HMI-SG will use the device address as fixed individual address. Otherwise, HMI-SG may change the device with DAA mechanism if the device address conflicts with other existing device on the KNX bus.

## Display alarms

When controller sends an alarm to HMI-SG, alarm indicator () will be on and the alarm number should be displayed blinking on screen. When HMI-SG is informed by controller that the alarm is disappeared or the alarm is confirmed by user with pressing any button, it will return to the previous status.

## Notes

---

### Engineering

The room unit receives its power from the connected controller via the 2-wire interface (low voltage, SELV). The room unit must be connected to the POL6XX or POL4XX controller with a unscreened two-core twisted pair cable.

### Mounting

- The device is suitable for semi-flush mounting with a recessed conduit box.
- The unit should not be mounted in recesses, shelving, behind curtains or doors or above or near direct heat sources.
- Avoid direct sun and draught.
- The conduit must be sealed on the device side, as currents of air in the conduit can affect the sensor reading.
- The admissible ambient conditions must be observed.
- Mounting instructions are enclosed with the device.

### Installation

Local installation regulations must be observed.



### Warning

**The equipment is not protected against accidental connection to AC 230 V.**

### Commissioning, Start-up characteristics

After an interruption of the connection to the 2-wire interface, parameter initialization will restart. If one parameter can't receive response, the next request will delay for 5 seconds to avoid flood frame on the Bus.

## Disposal

---



The device is considered electrical and electronic equipment for disposal in terms of the applicable European Directive and may not be disposed of as domestic garbage.

- Dispose of the device through channels provided for this purpose.
- Comply with all local and currently applicable laws and regulations.

## Technical data

Supply voltage	Operating voltage	DC 21...30 V	
	The room unit receives its power from the connected controller, via the 2-wire interface (SELV, according to HD384)		
	Power consumption (from controller)	Max. 0.31 VA	
Operating data	Measuring element	NTC resistance sensor	
	Measuring range	0...40 °C	
	Thermal time constant (sensor)	Approx 15 s	
	Measuring accuracy (5...30 °C)	±1.0 K	
	Measuring accuracy (25 °C)	±0.5 K	
Display	Type	Segment LCD	
	Functions displayed	Set point adjustment	
		– Operating mode	
		– Manually selected fan speed	
	Time display	– Time and weekday setting	
		Parameter setting (only when selected)	
Interfaces	Type of interface between controller and room unit	2-wire interface KNX	
	Number of HMI-SG connected to a controller without additional power supply	6	
	Baud rate	9.6 kbps	
Cable connections	Connection terminals (screw terminals)	Solid or stranded conductors 0.8...2.5 mm <sup>2</sup>	
	Cable type	2-core, twisted pair, unscreened	
	Max. distance between 2 units	700 m	
Housing protection	Protection standard to EN 60529	IP 30	
Protection class	Insulation protection class	III	
Ambient conditions	IEC 60721-3	Normal operation	Transport
	Ambient air conditions	Class 3K3	Class 2K3
	Temperature	5...40 °C	-25...70 °C
	Humidity	<85% r.h.	<93% r.h.
	Mechanical conditions	Class 3M1	Class 2M2
Industry standards	EU Conformity (CE)	CB1T3942xx	
	Environmental compatibility		
	The product environmental declaration CB1E3261 contains data on environmentally compatible product design and assessments (RoHS compliance, materials composition, packaging, environmental benefit, disposal). Listings	UL916, UL873 CSA C22.2M205	
Dimensions	See "Dimensions"		
Color	Front housing, rear housing, key buttons	RAL9003 – signal white	
Weight	Excluding packaging	108 g	

## Connecting diagrams

### Terminal layout:

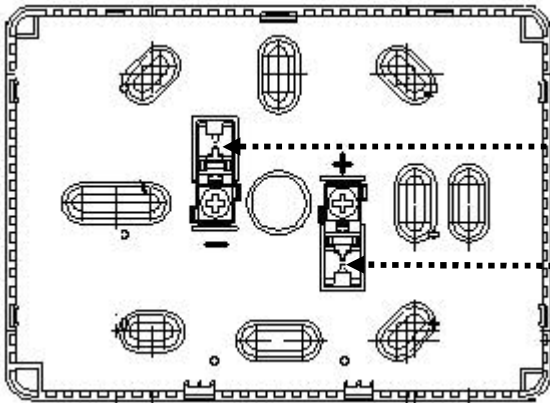

2-wire interface, power supply  
 + Device power supply, data (positive)  
 - Device power supply, data (negative)

CE -

CE +

### Wiring diagram

The example below shows the room unit connected to POL6xx or POL4XX controller.

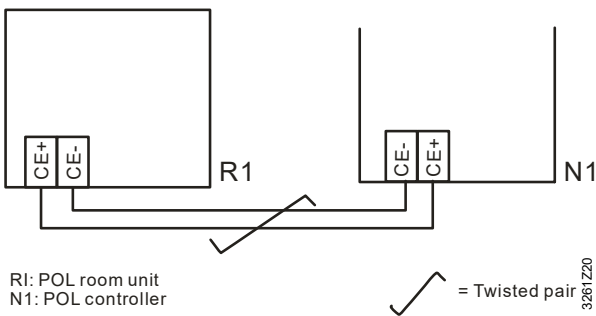

R1: POL room unit  
 N1: POL controller

✓ = Twisted pair

## Dimensions

POL822.60/XXX

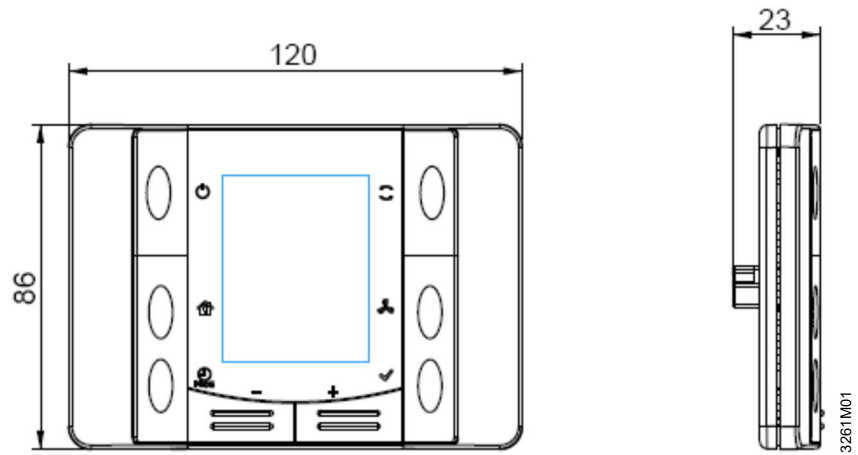

POL822.70/STD

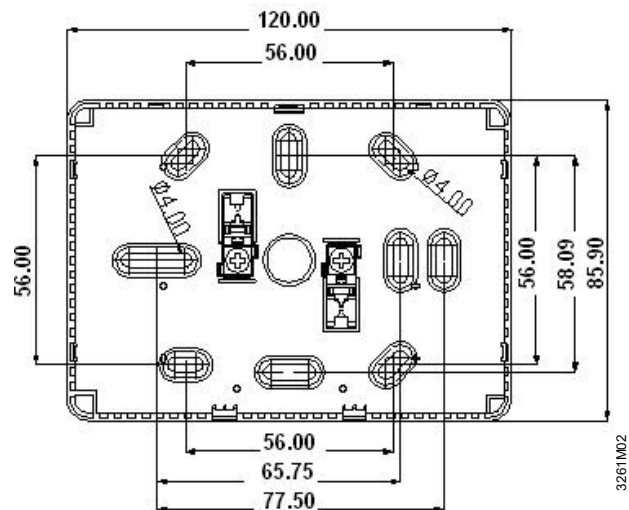
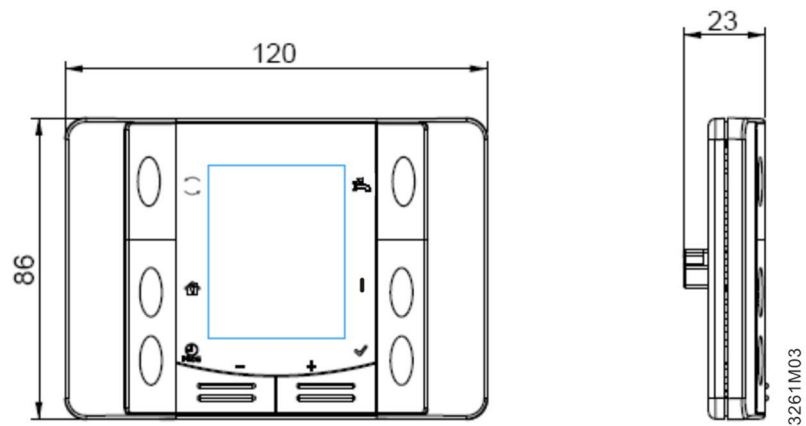

All figures in mm